

WTVF-VF1-V1.1-5

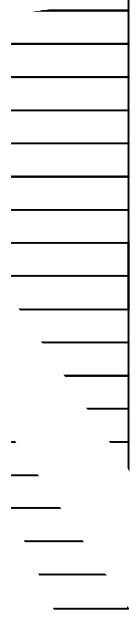

吉士电梯

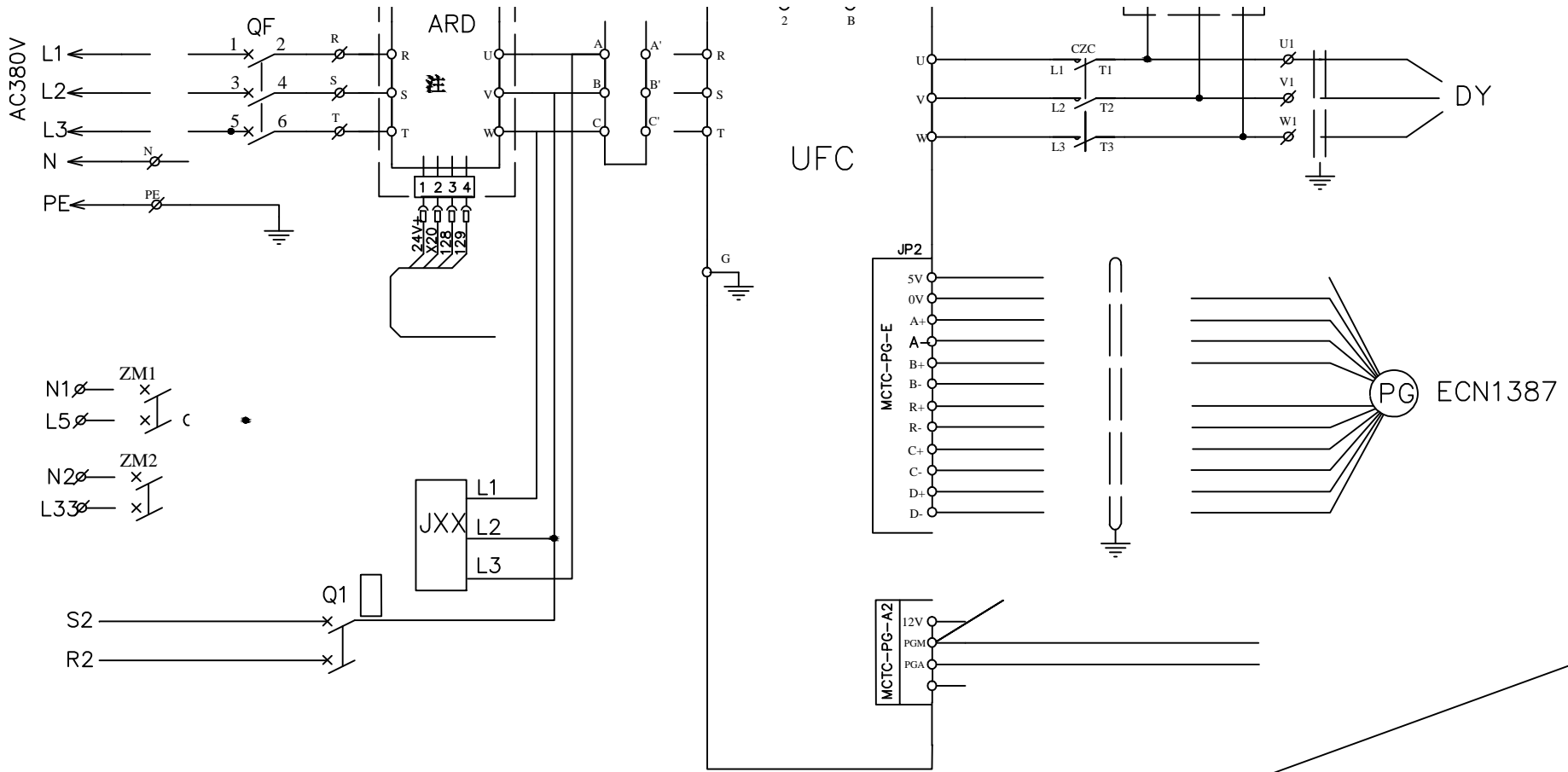

更改文件号

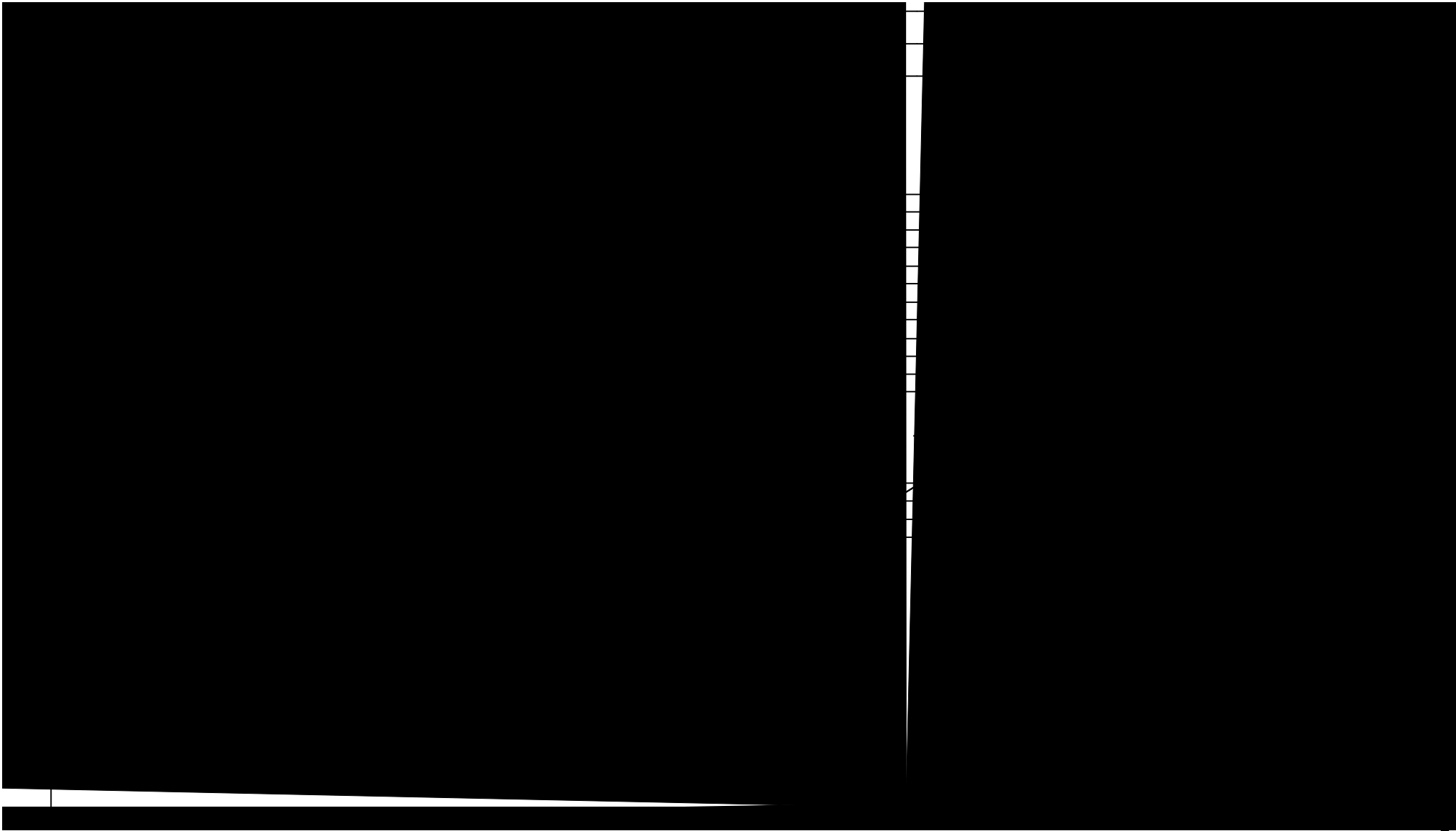

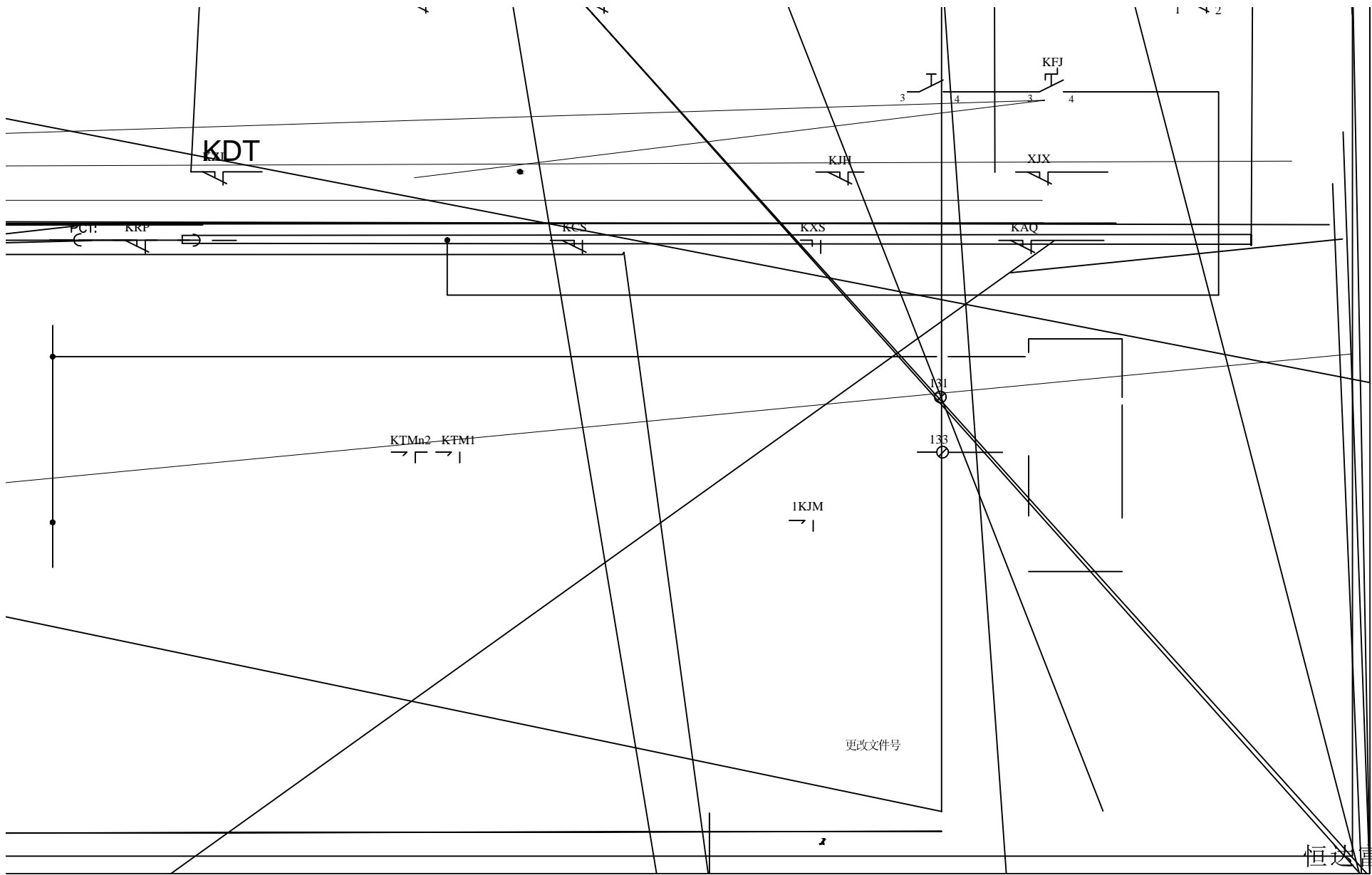

更改文件号

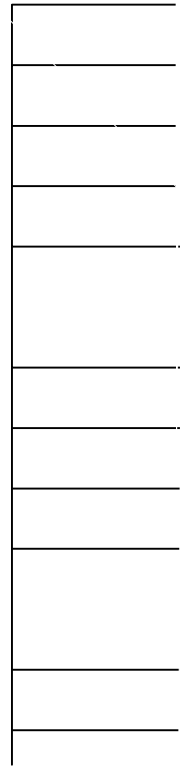
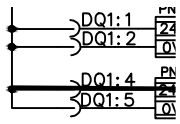

24V+

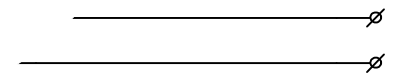
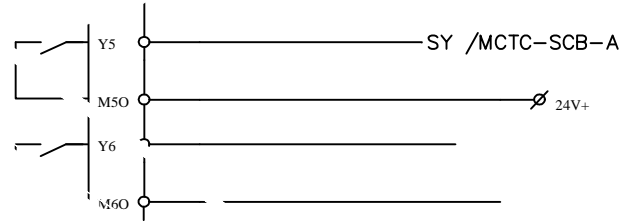
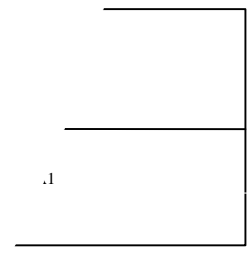
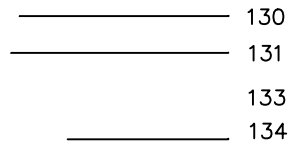

恒达富士电梯  
有

— F1



FJ-JXB

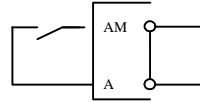

更改文件号

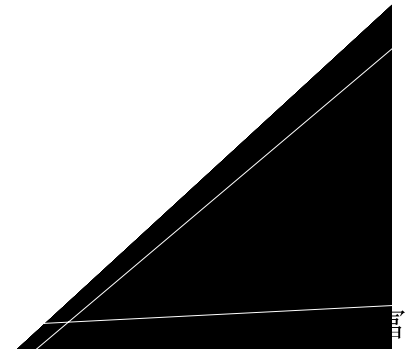
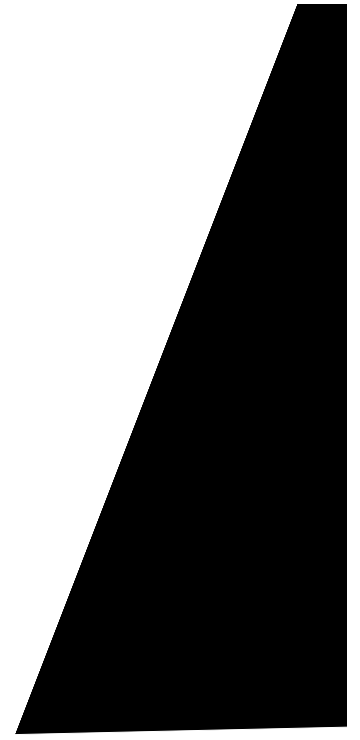

富士电梯  
有





更

恒达富士电梯  
有

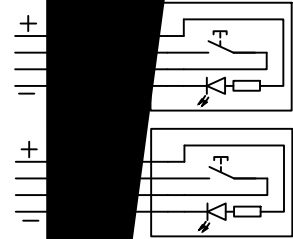

更改文

恒达富士电梯  
有

FJ-HB

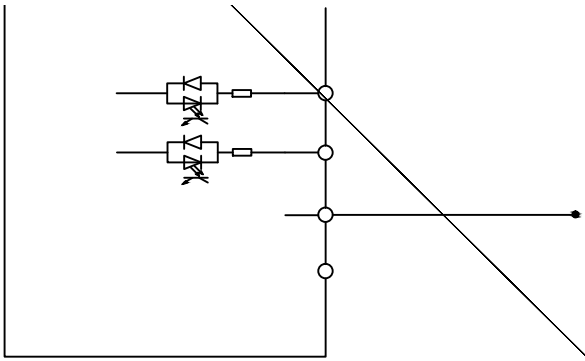

.

.

.

.

.

.

恒达富士电梯  
有

富士电梯  
有

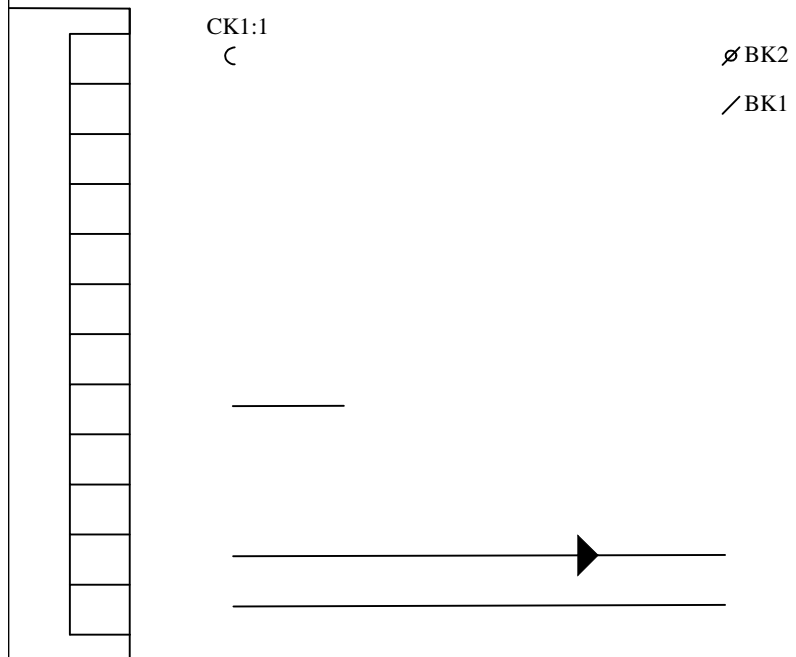
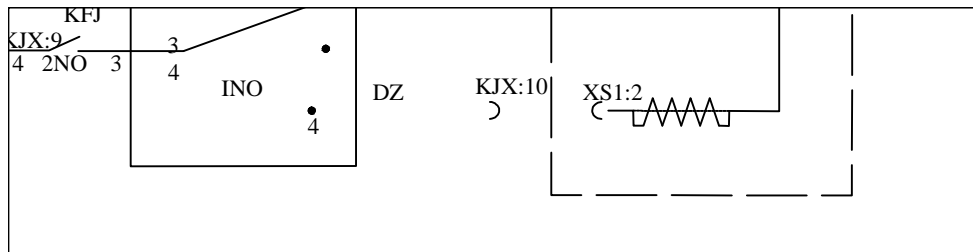

更改文件号

恒达

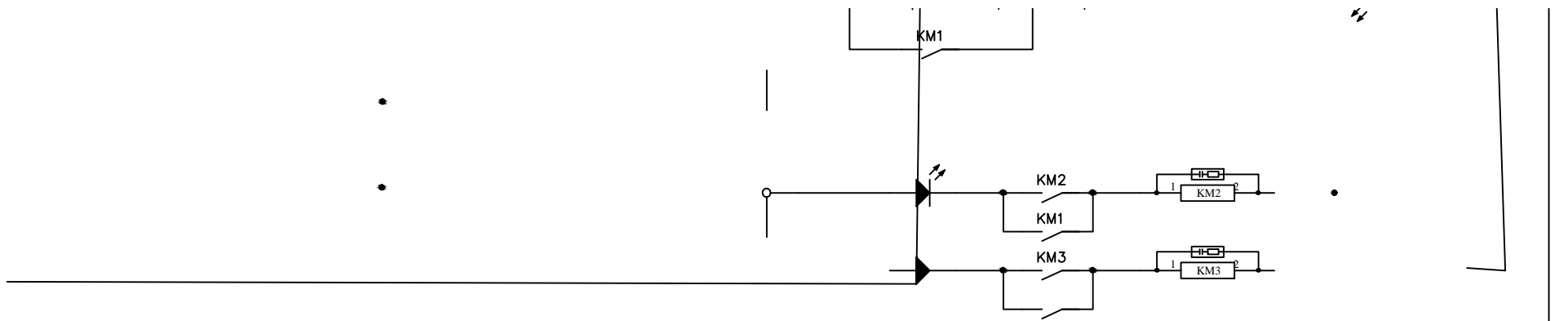

FJ-MPU-V4.0

更改文件号

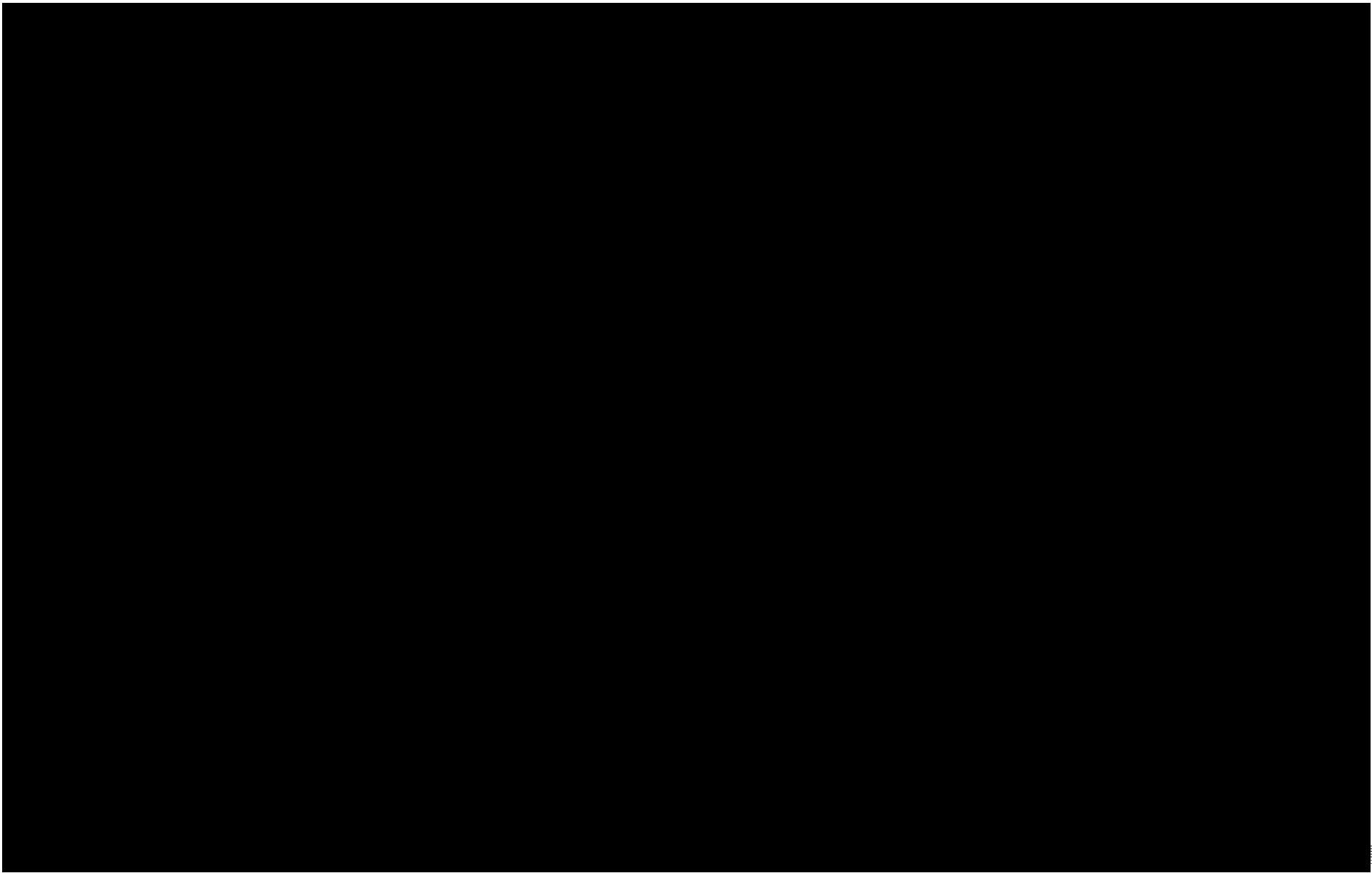

富士电梯  
有







富士电梯  
有

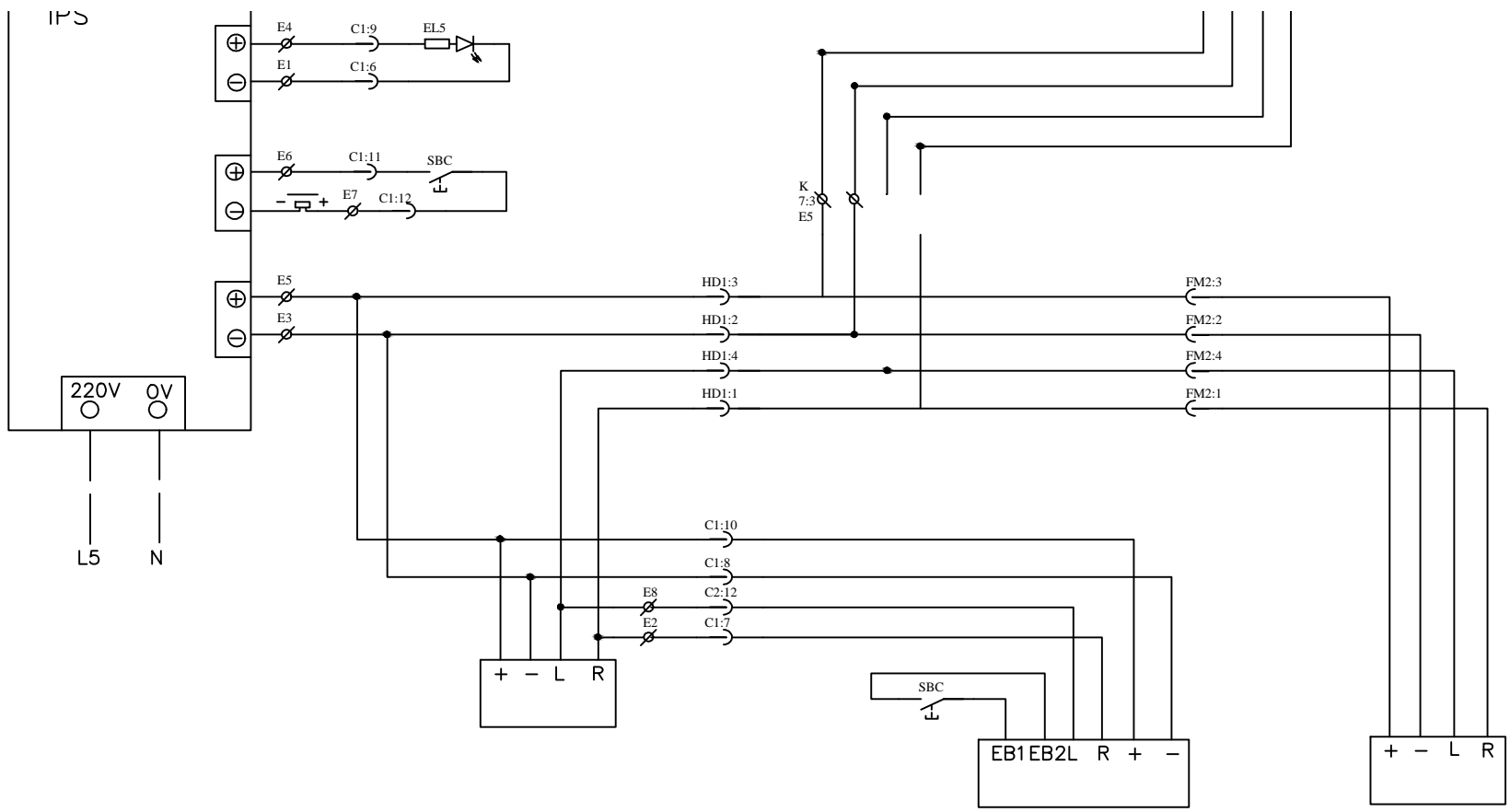

更改文件号

SFK

更改

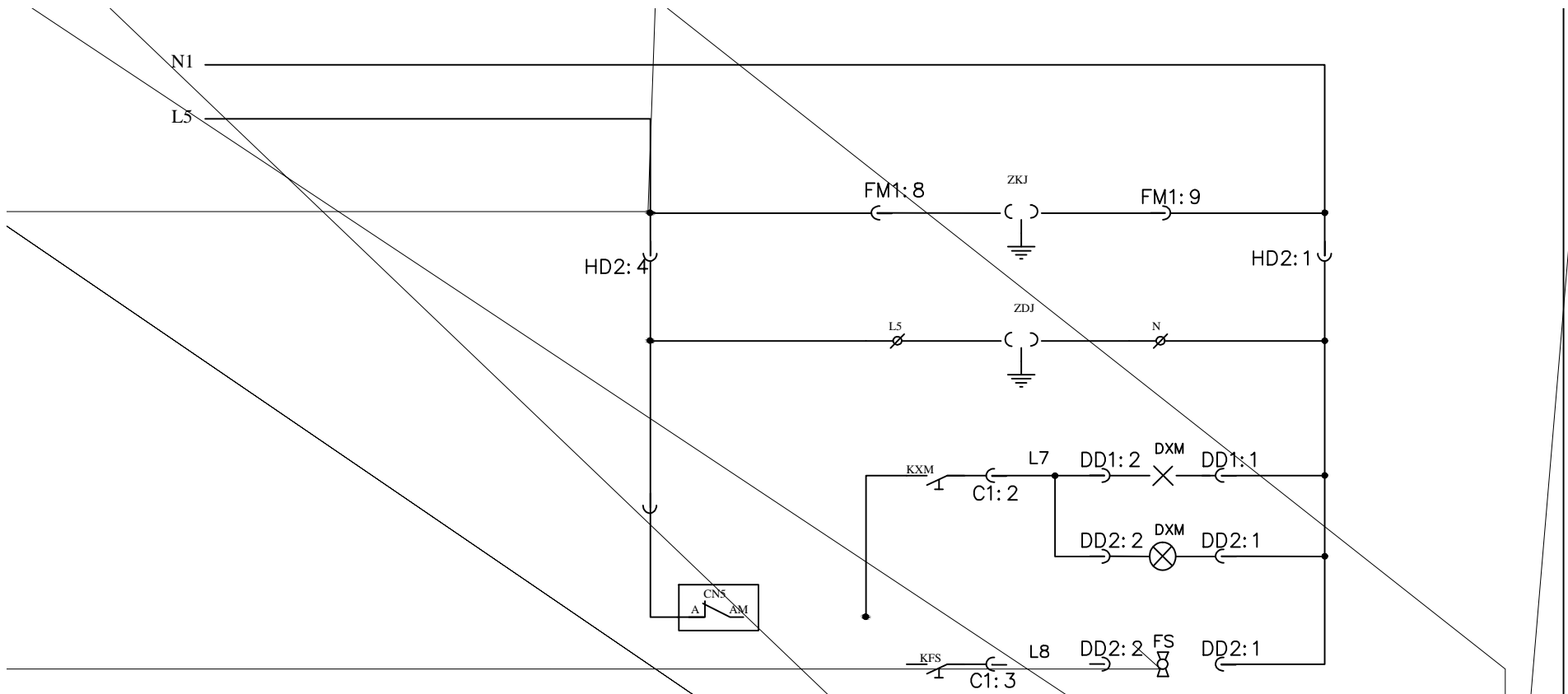

标记 处数 分区 更改文件号 签名 年月日

标准化

阶段标识 重量 比例

校对

审核

工艺

批准

共 28 张 第 20 张

恒达富士电梯  
有



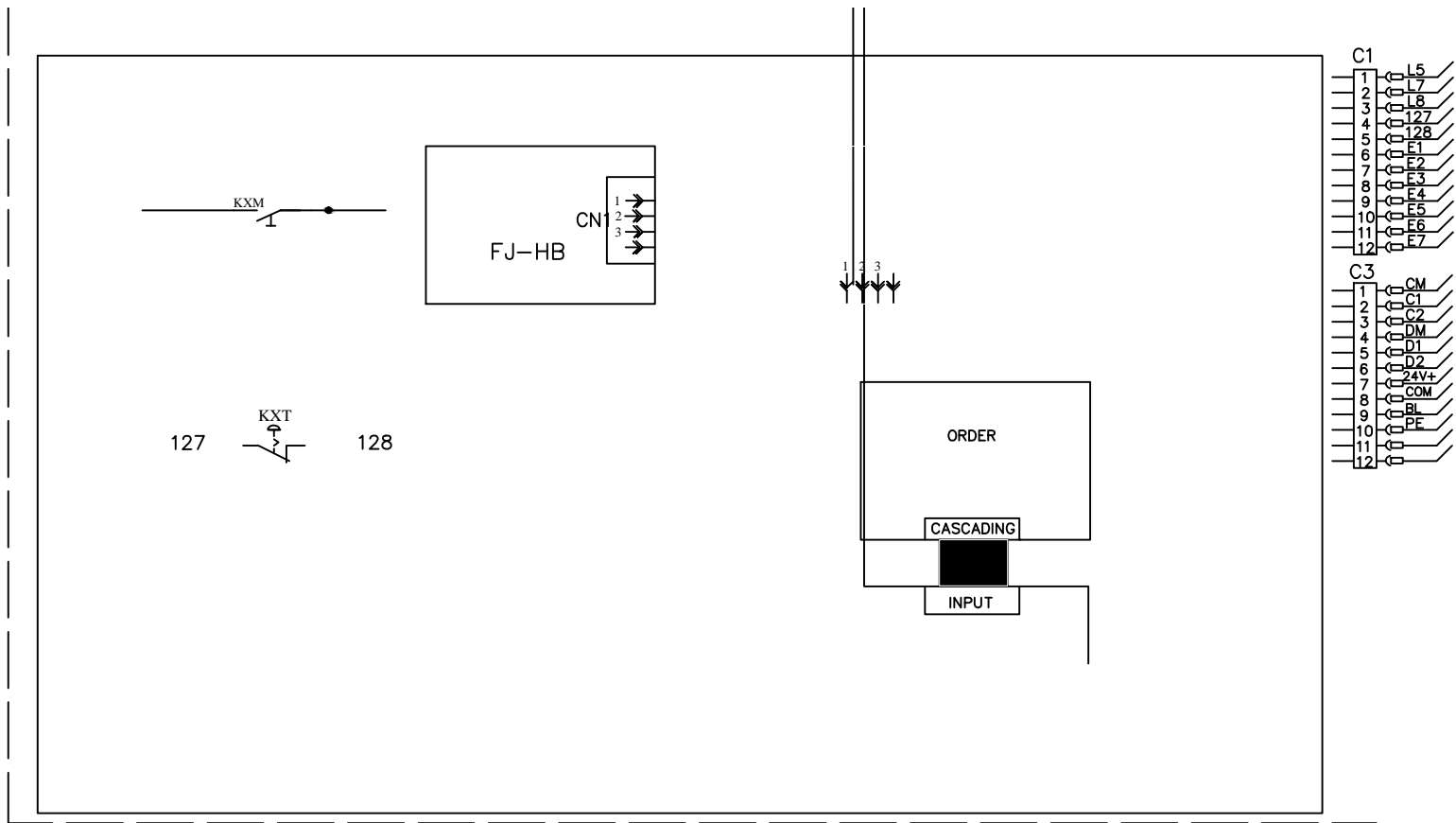

更改文件号

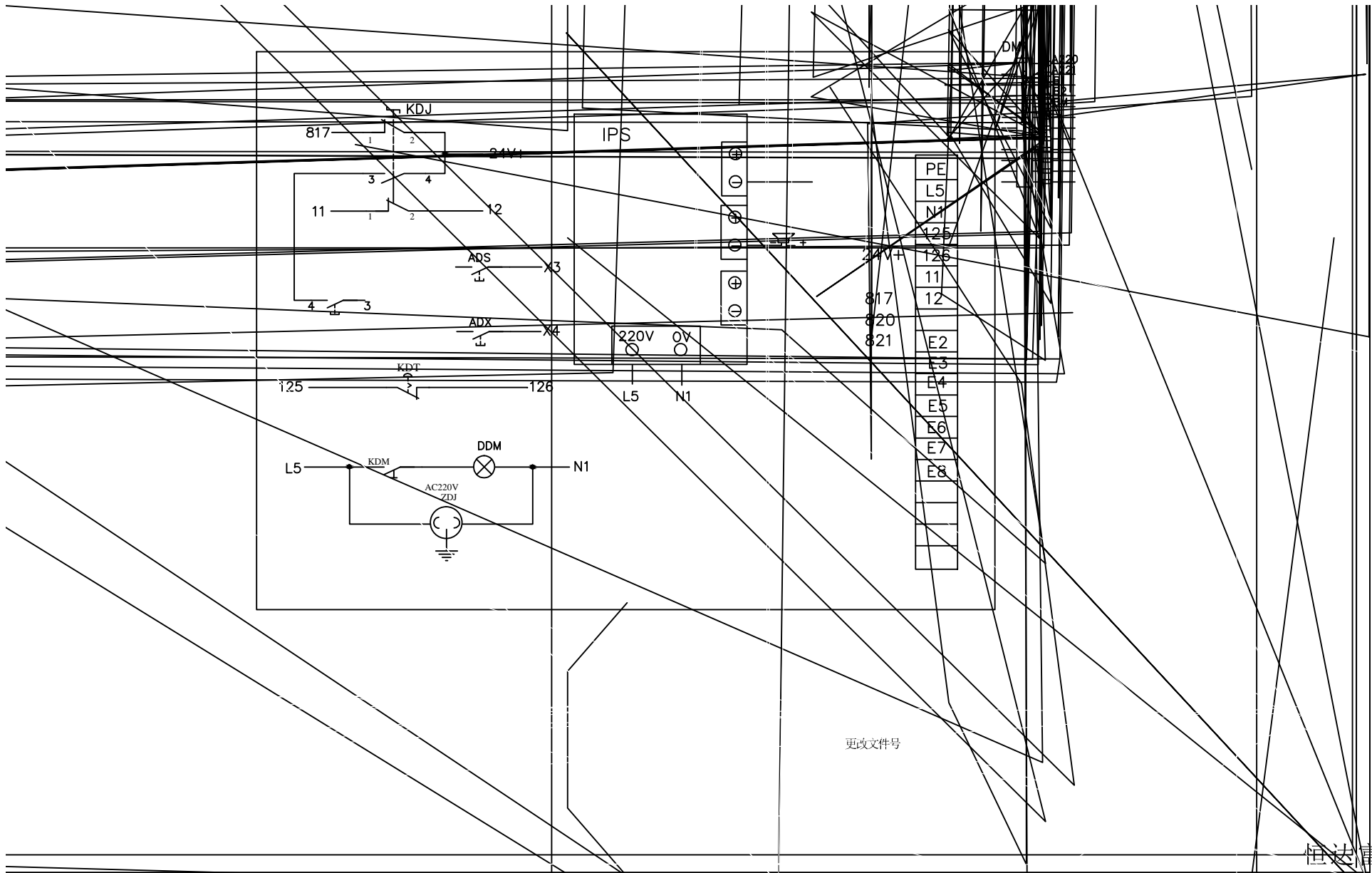



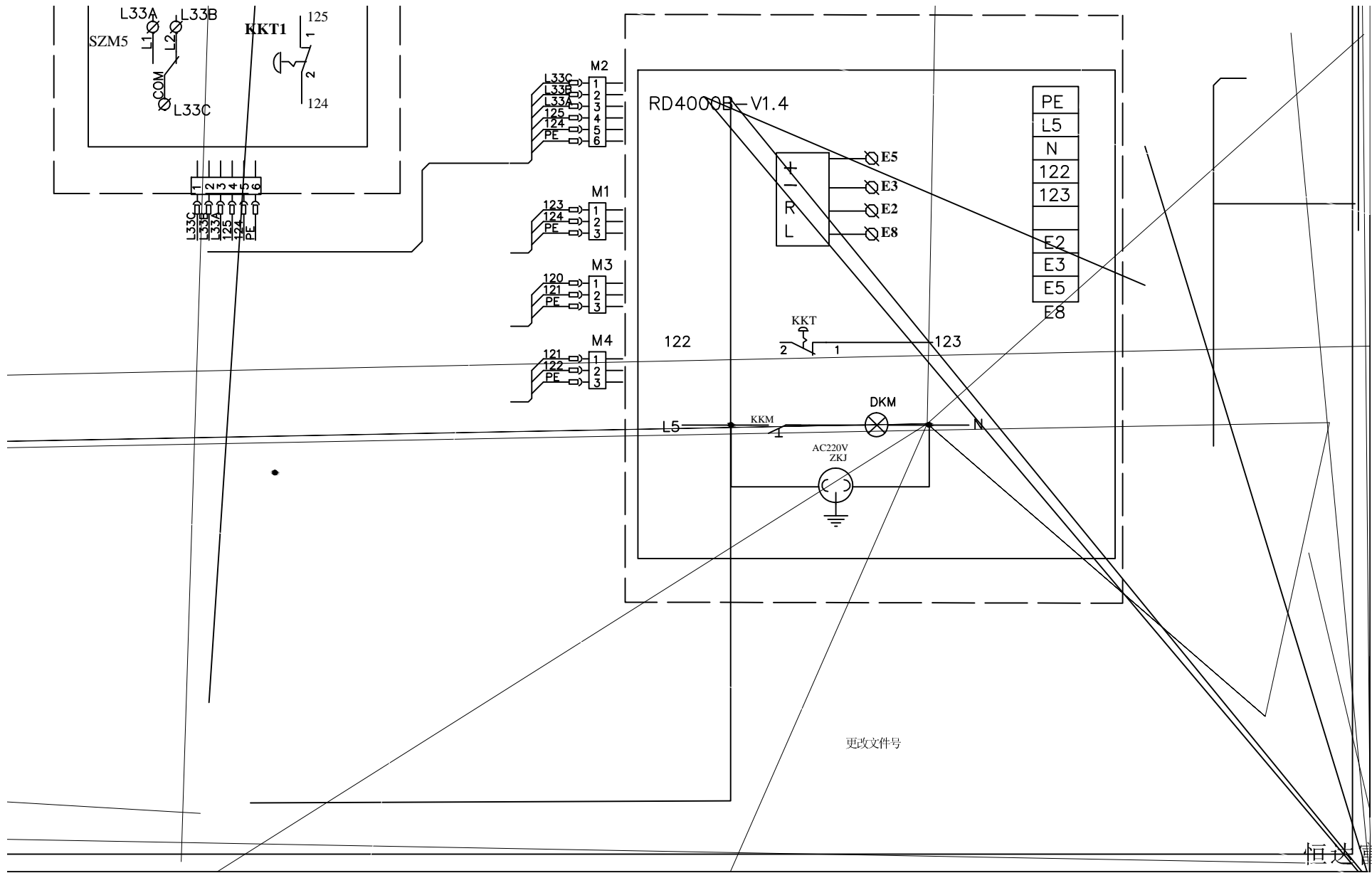

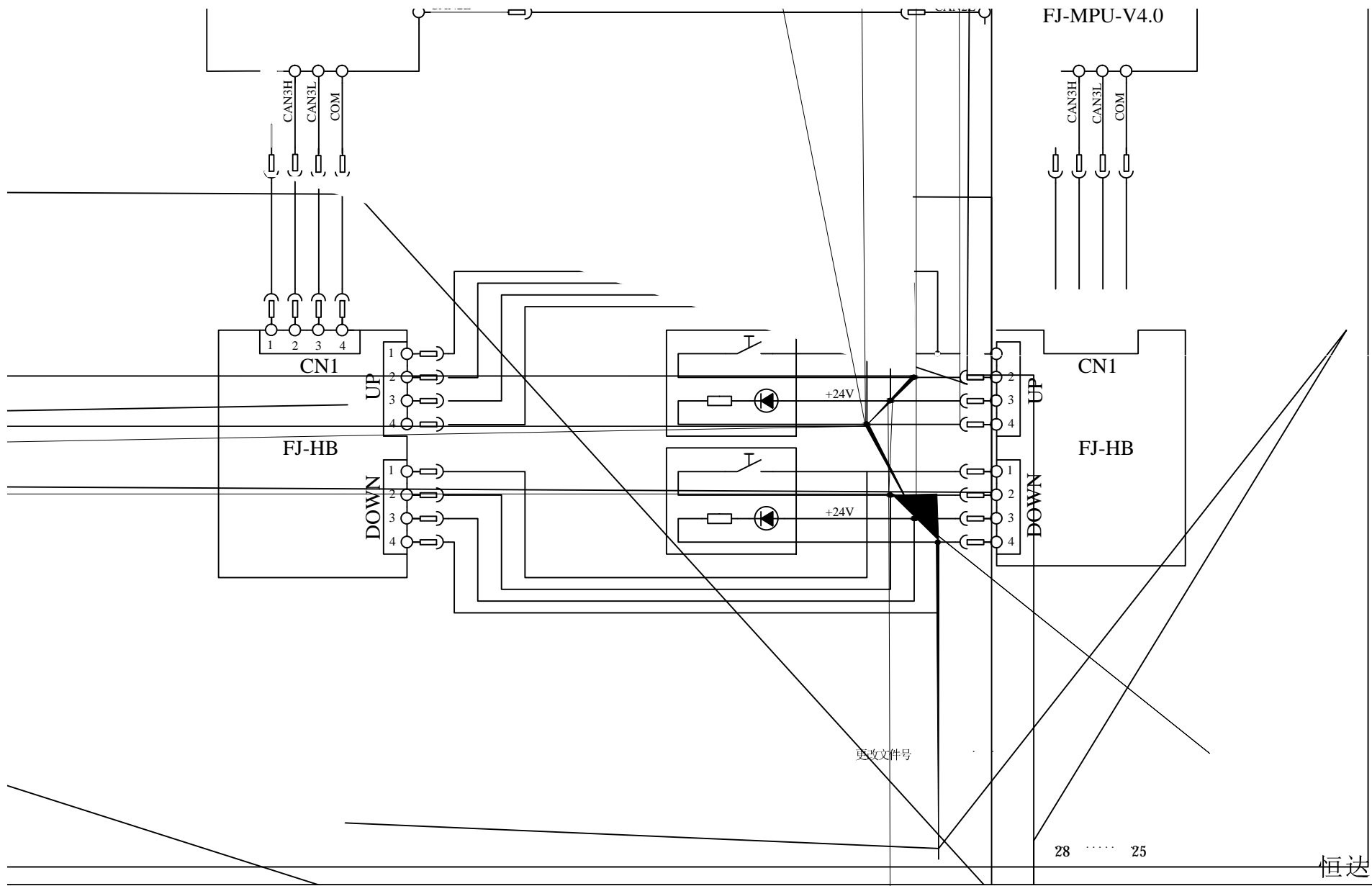

更改文件号

28 ..... 25

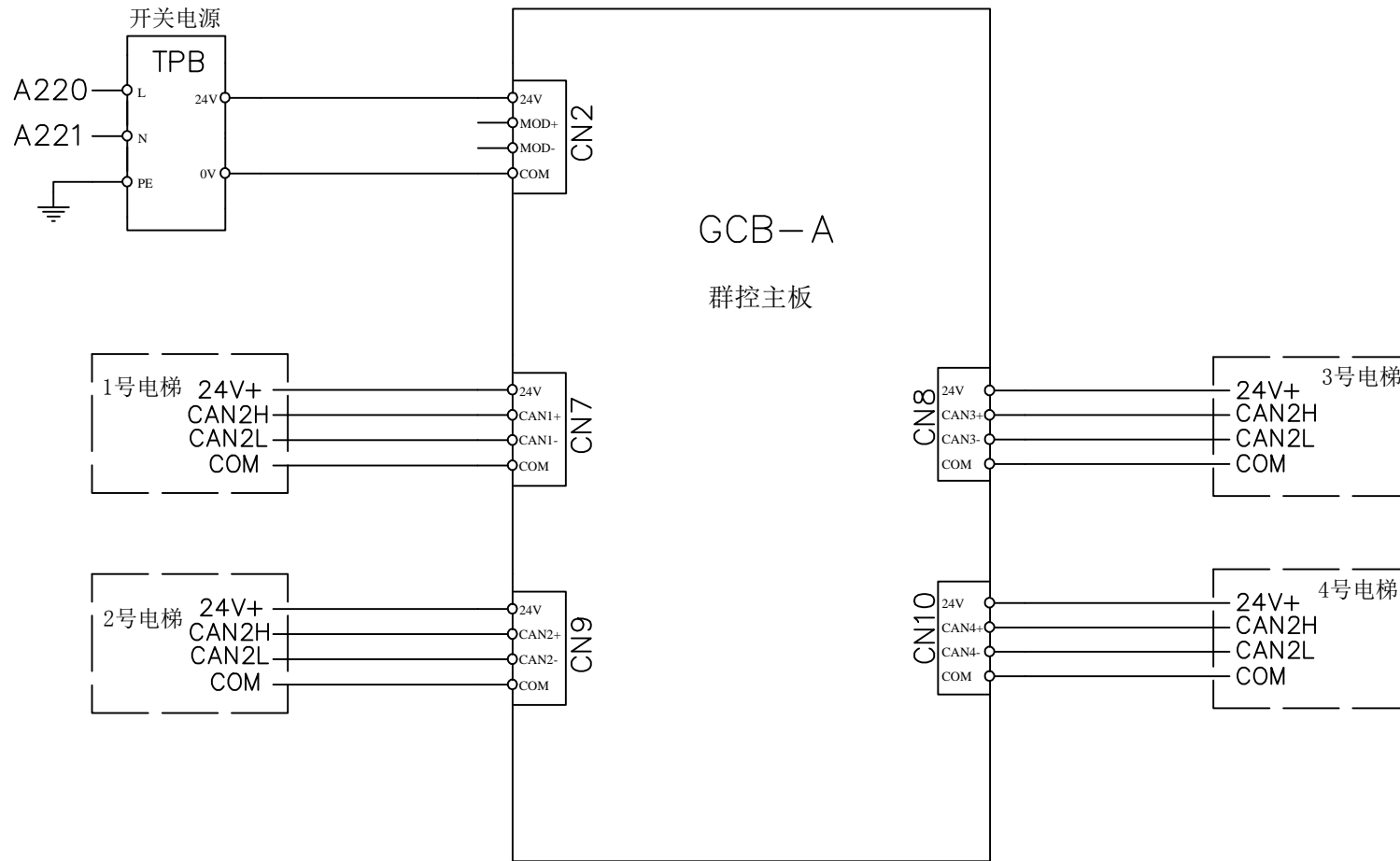

						群控板-4			恒达富士电梯有限公司	
标记	处数	分区	更改文件号	签名	年月日					
设计	汪军		标准化	王爱敏		阶段标识	重量	比例		
校对	沈丹									
审核	吴伟国									
工艺	严红星		批准	刘万兵		共 28 张		第 26 张		H1501000

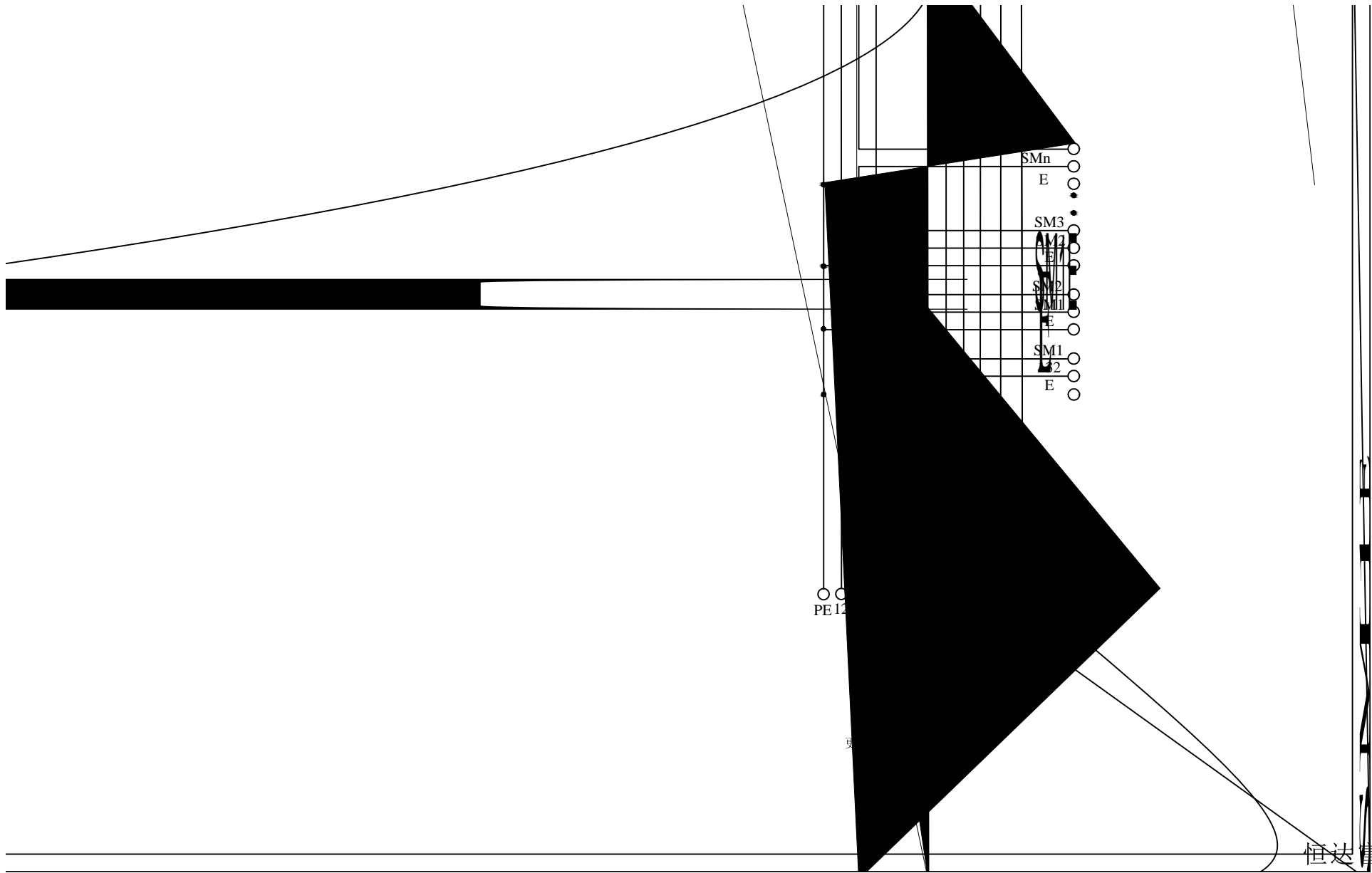

SMn

E

SM3

SM2

SM1

E

PE 12

恒达富士电梯  
有

